

2016 Mazda MX-5
 AUDIO SYSTEM (WITHOUT CENTER DISPLAY)

0920-1a

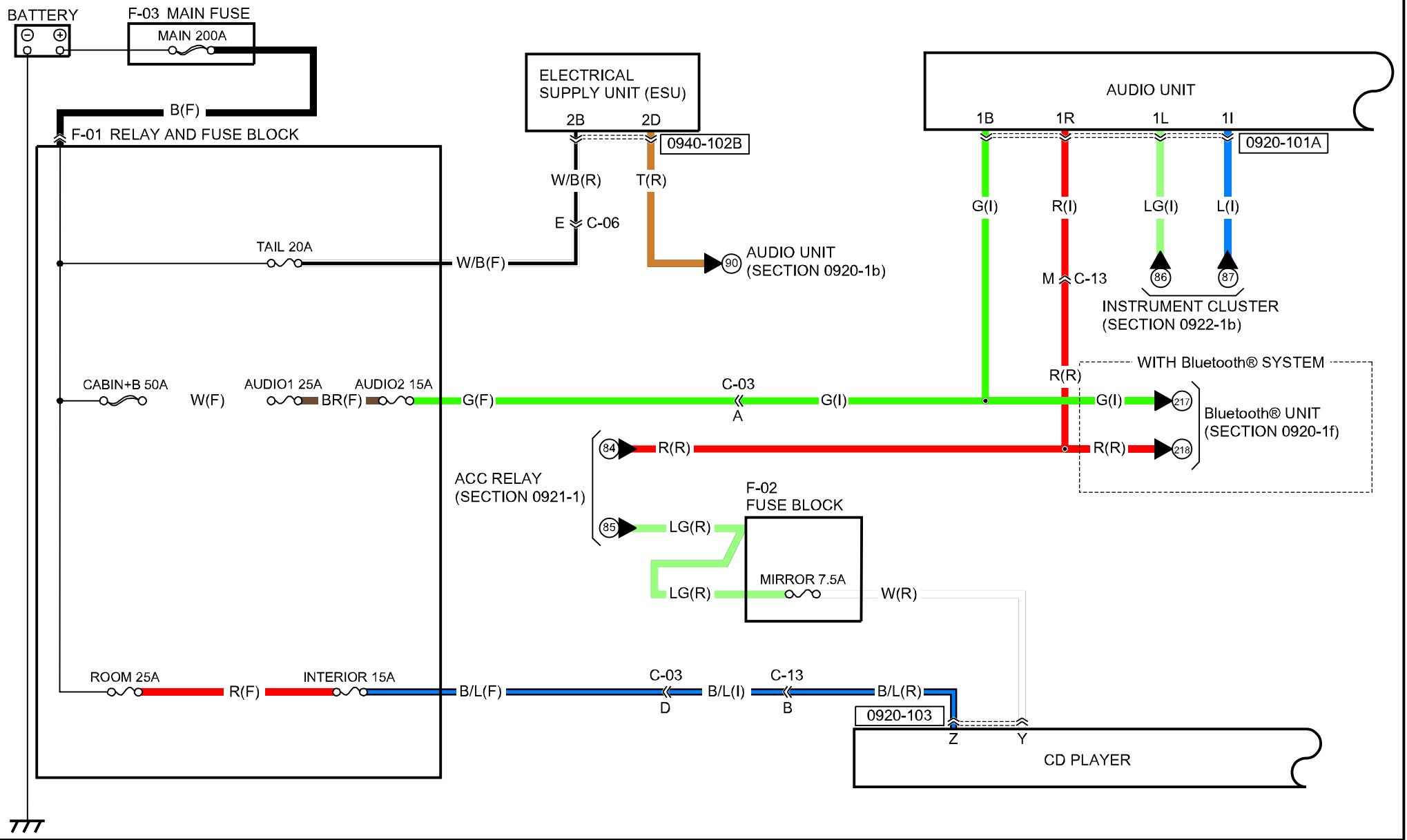

2016 Mazda MX-5
AUDIO SYSTEM (WITHOUT CENTER DISPLAY)

0920-1a

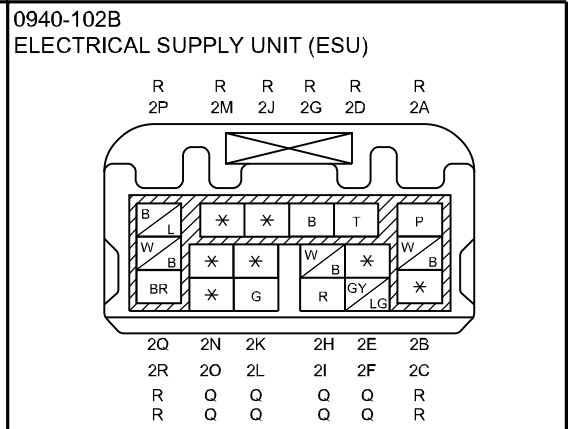
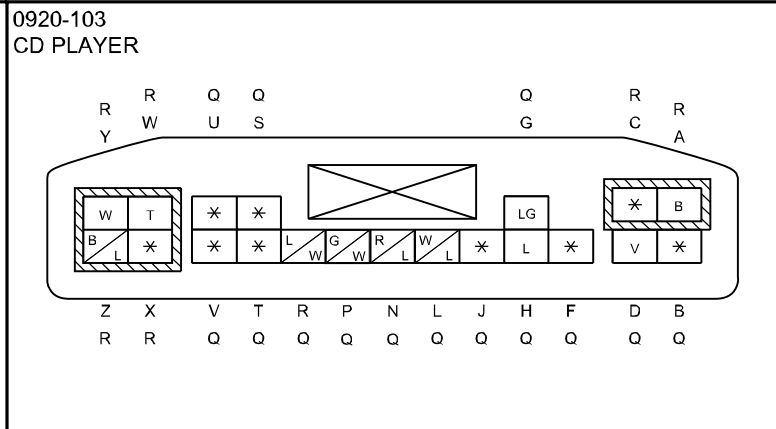
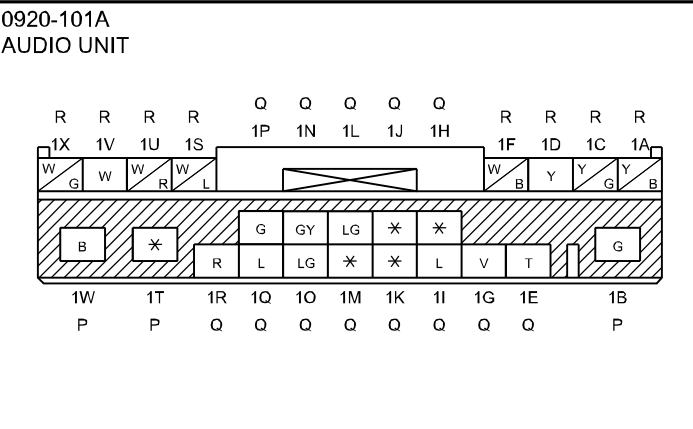

| Electrical supply unit (ESU) Terminal Voltage Table (Reference) | | |
|---|---|---|
| Terminal | Measurement condition | Voltage (V) |
| 2B | Under any condition | B+ |
| 2D | Light switch is in ON position | B+ |
| | Ignition is switched ON (engine off or on) Light switch is in OFF position | Voltage changes according to the tester specification, therefore determination is not possible. |

2016 Mazda MX-5
AUDIO SYSTEM (WITHOUT CENTER DISPLAY)

0920-1a

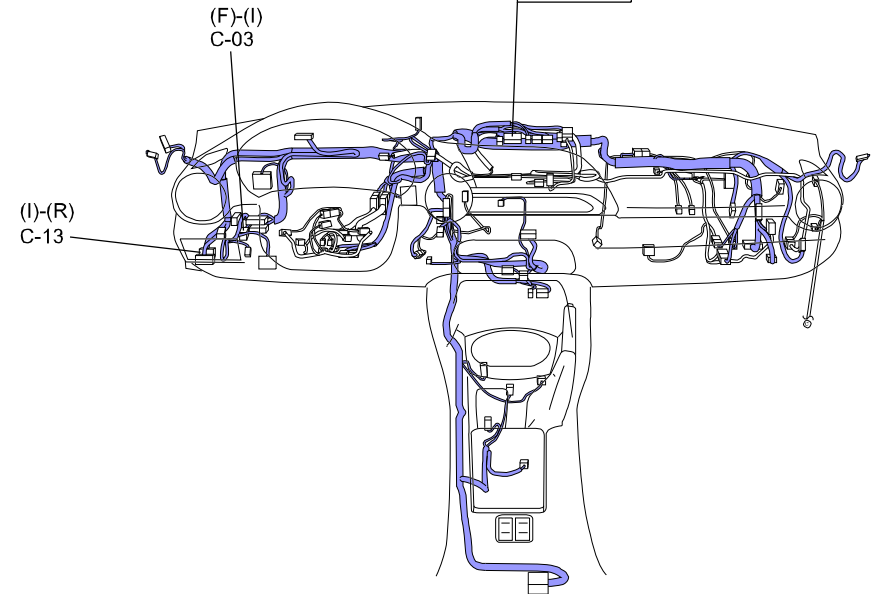
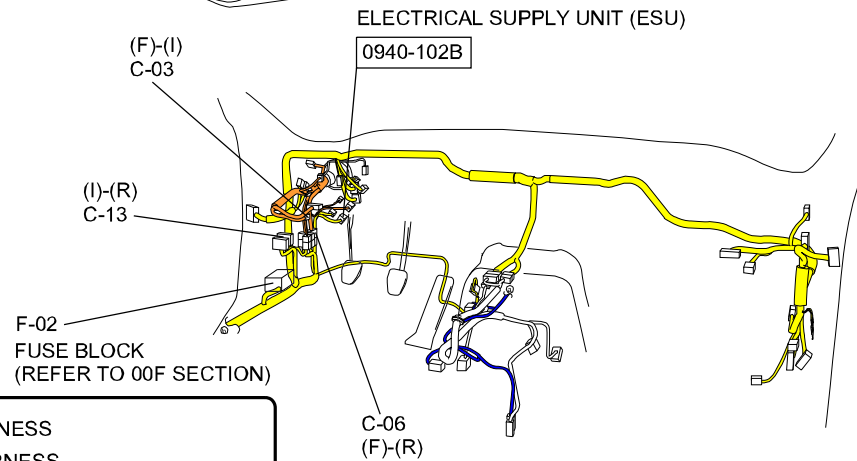
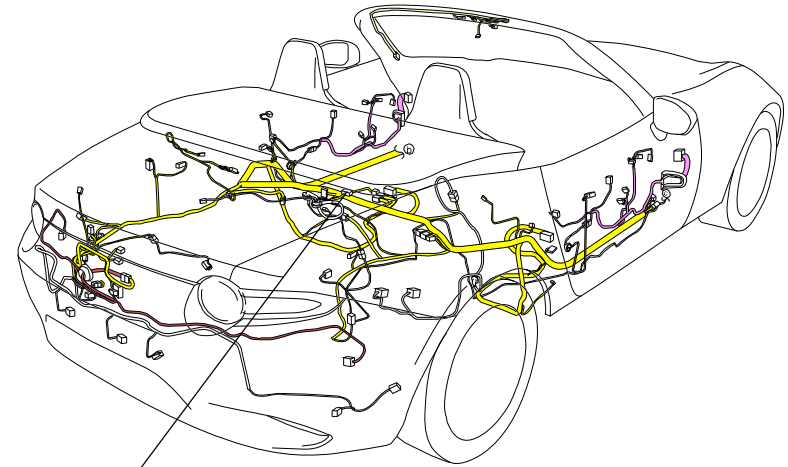
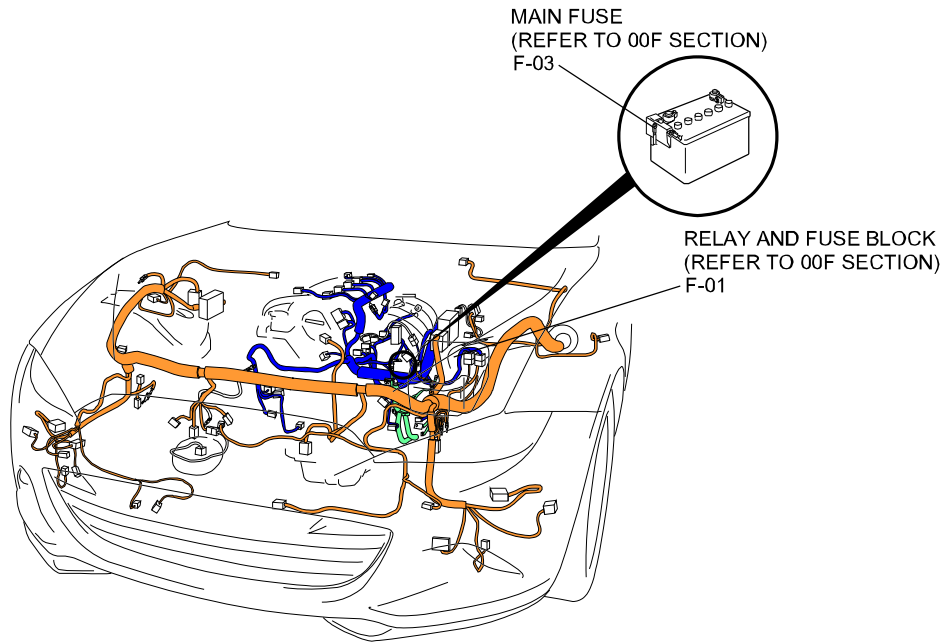

- : FRONT HARNESS
- : ENGINE HARNESS
- : REAR HARNESS
- : REAR No.4 HARNESS
- : INSTRUMENT PANEL HARNESS
- : EMISSION HARNESS
- : DOOR HARNESS
- : INTERIOR LIGHT No.2 HARNESS

2016 Mazda MX-5
AUDIO SYSTEM (WITHOUT CENTER DISPLAY)

0920-1b

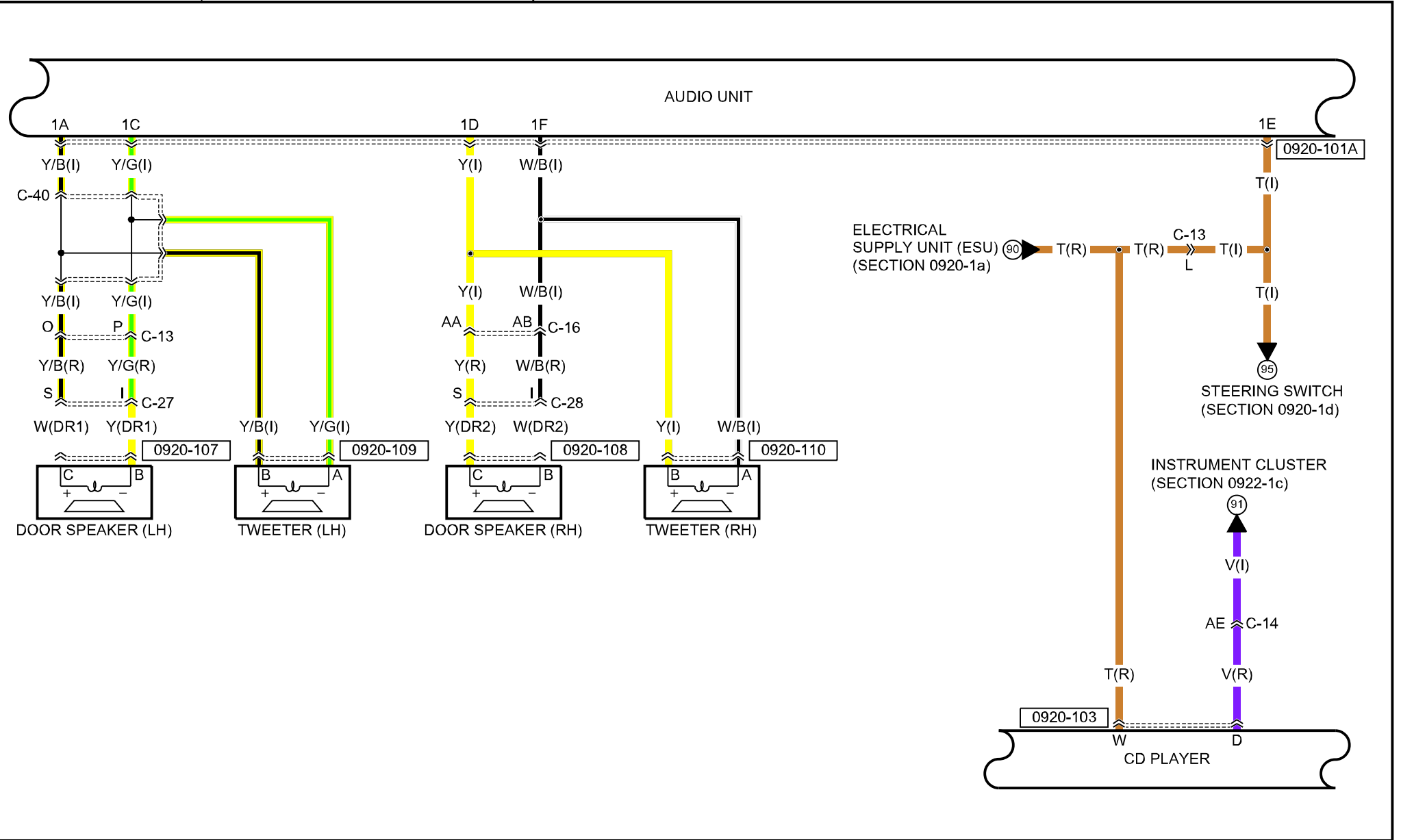

2016 Mazda MX-5
AUDIO SYSTEM (WITHOUT CENTER DISPLAY)

0920-1b

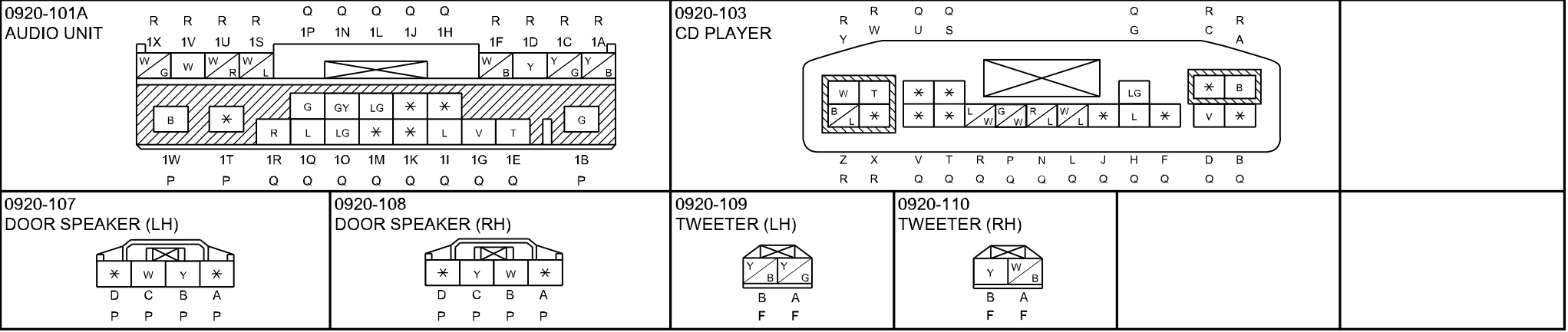

Door speaker
Door speaker resistance
Without Bose®: 3.4—4.6 ohms
With Bose®: approx. 2.1 ohms

Tweeter
Tweeter resistance
Without Bose®: 3.4—4.6 ohms
With Bose®: 3.06—4.74 ohms

2016 Mazda MX-5
AUDIO SYSTEM (WITHOUT CENTER DISPLAY)

0920-1b

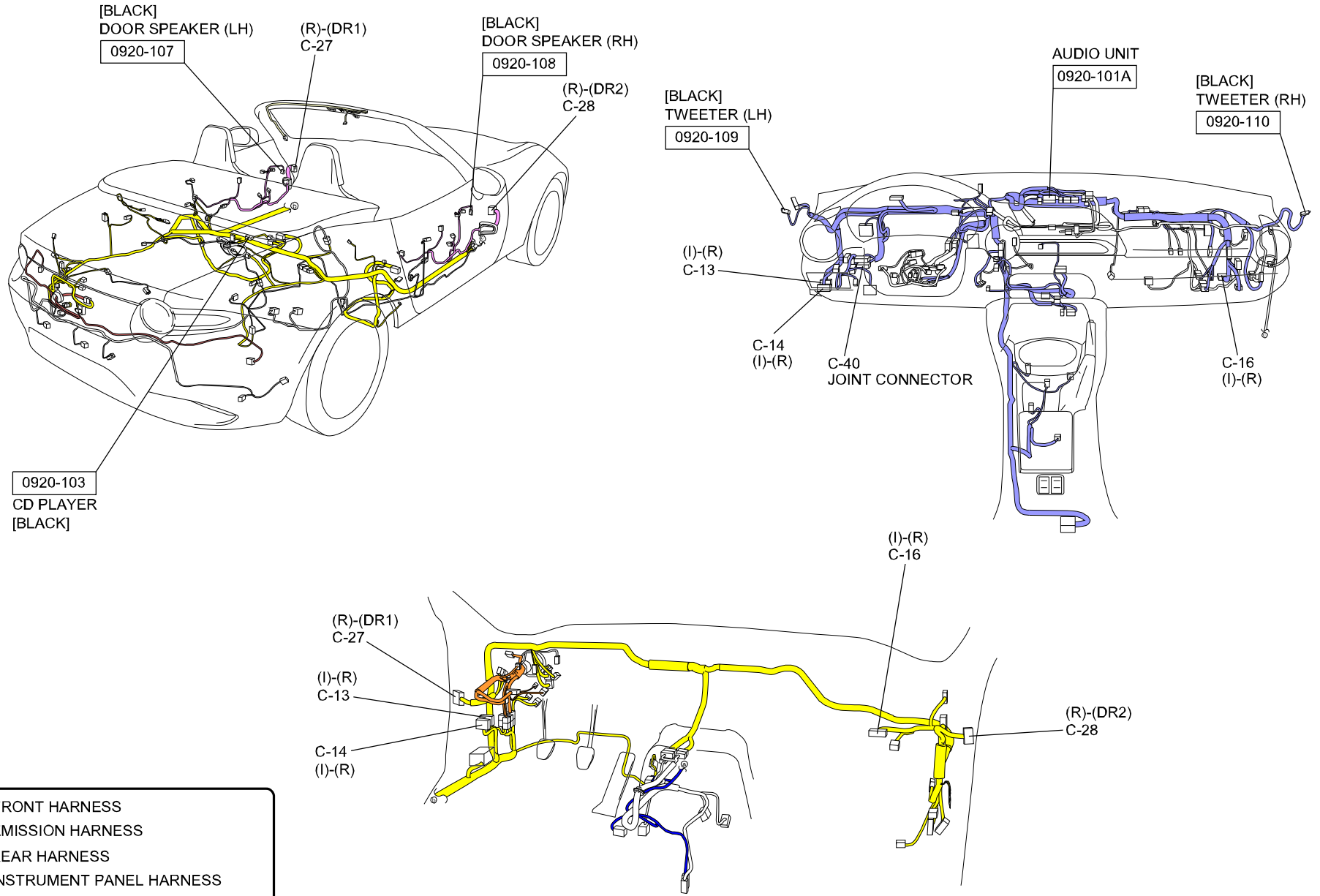

- : FRONT HARNESS
- : EMISSION HARNESS
- : REAR HARNESS
- : INSTRUMENT PANEL HARNESS
- : REAR No.4 HARNESS
- : DOOR HARNESS
- : INTERIOR LIGHT No.2 HARNESS

2016 Mazda MX-5
 AUDIO SYSTEM (WITHOUT CENTER DISPLAY)

0920-1c

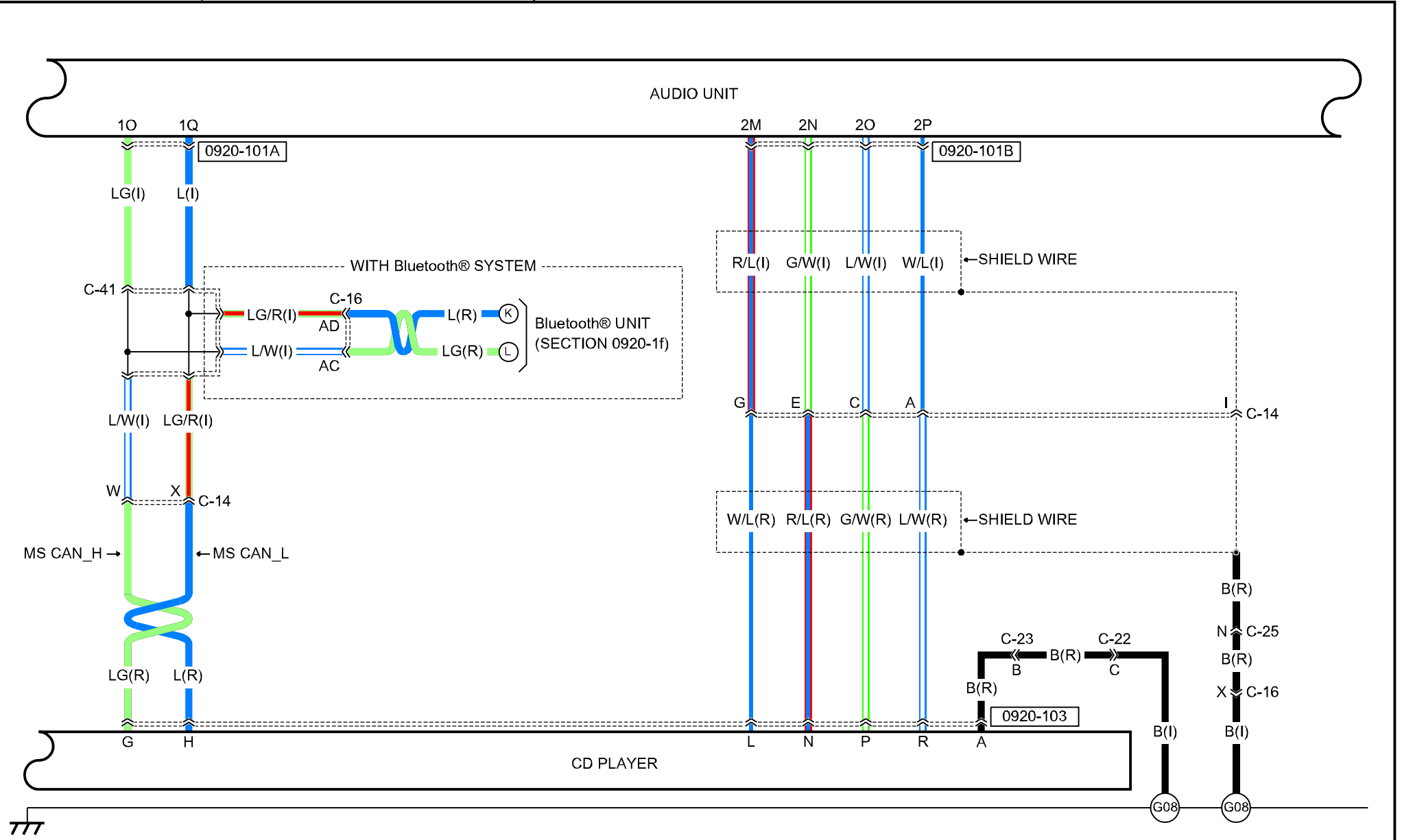

2016 Mazda MX-5
AUDIO SYSTEM (WITHOUT CENTER DISPLAY)

0920-1c

0920-101A
AUDIO UNIT

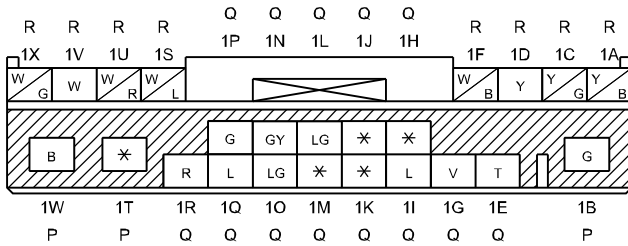

0920-101B
AUDIO UNIT

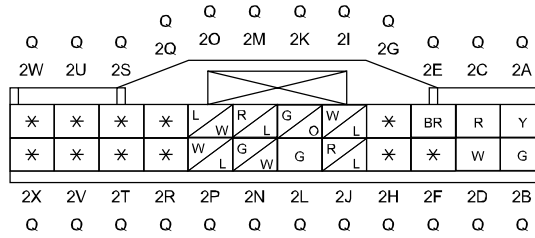

0920-103
CD PLAYER

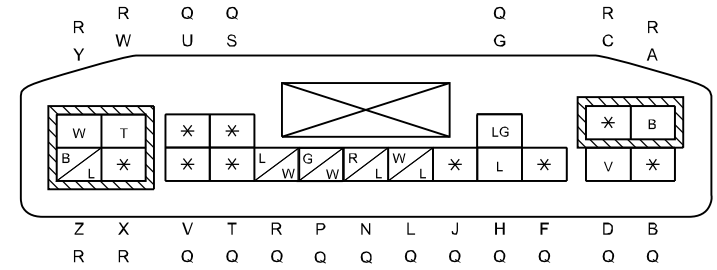

2016 Mazda MX-5
AUDIO SYSTEM (WITHOUT CENTER DISPLAY)

0920-1c

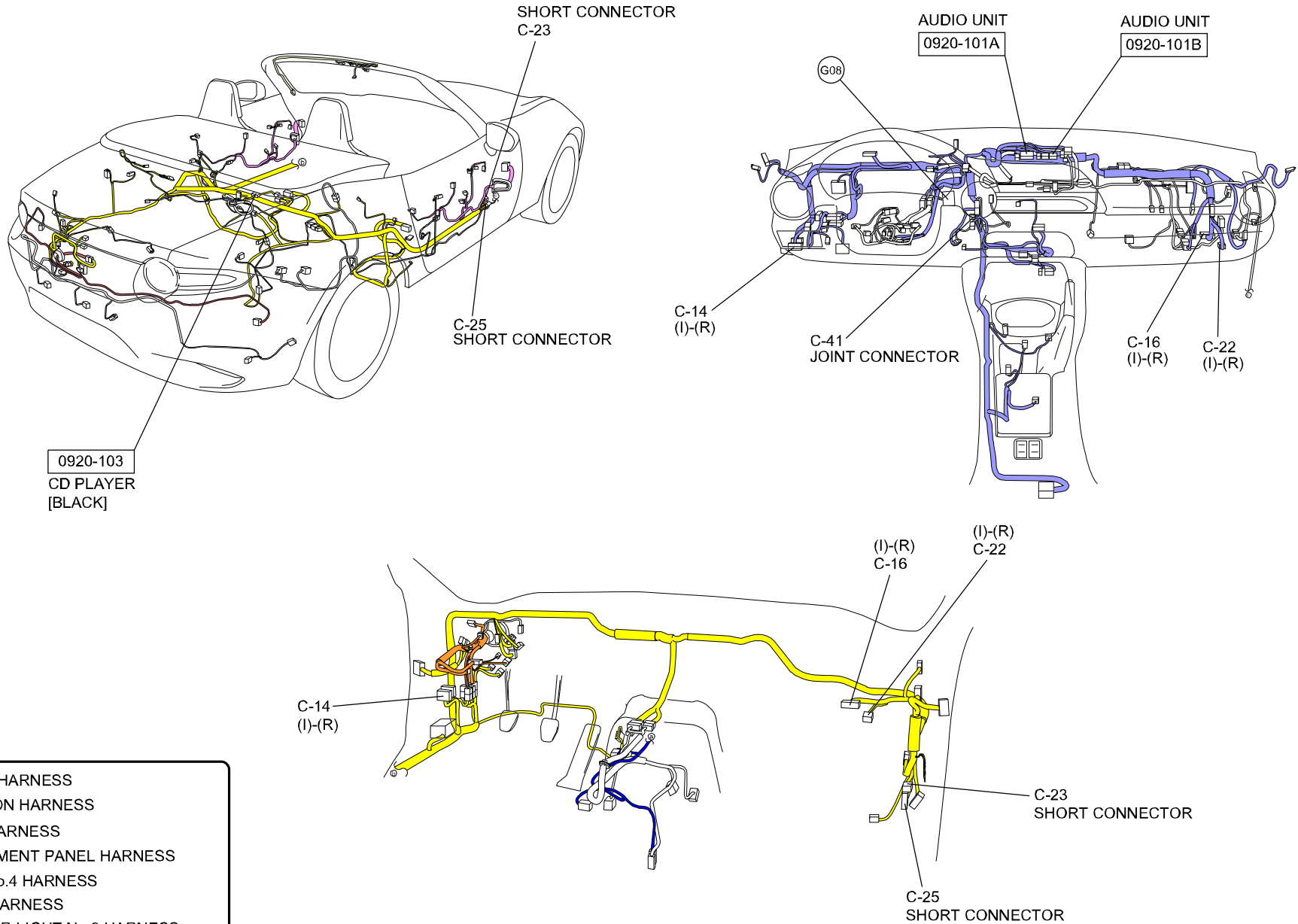

- : FRONT HARNESS
- : EMISSION HARNESS
- : REAR HARNESS
- : INSTRUMENT PANEL HARNESS
- : REAR No.4 HARNESS
- : DOOR HARNESS
- : INTERIOR LIGHT No.2 HARNESS

2016 Mazda MX-5
AUDIO SYSTEM (WITHOUT CENTER DISPLAY)

0920-1d

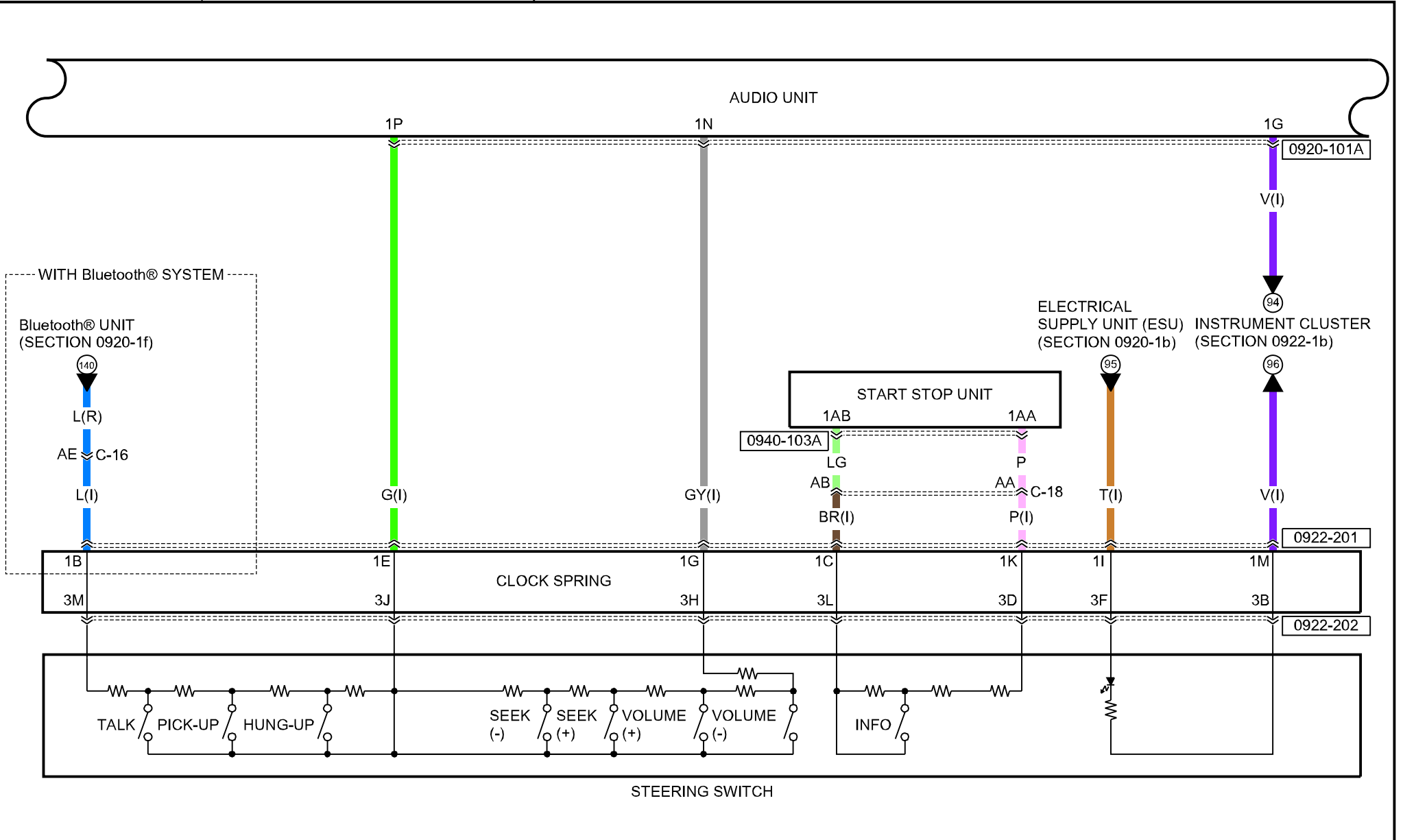

2016 Mazda MX-5
AUDIO SYSTEM (WITHOUT CENTER DISPLAY)

0920-1d

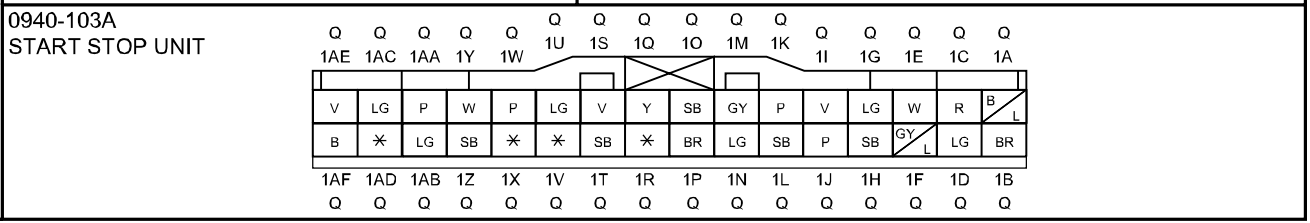
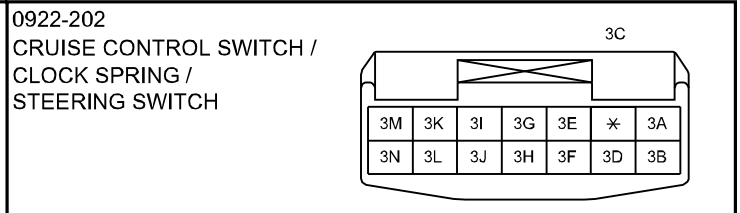
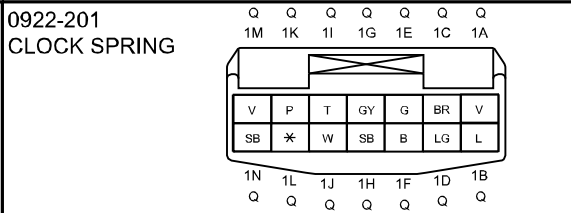
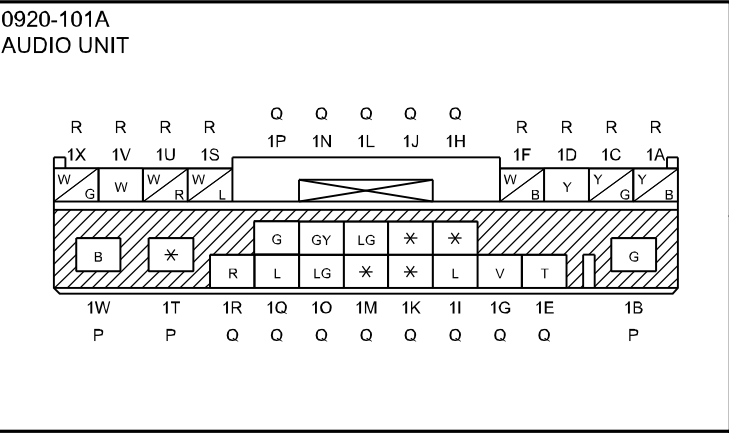

Start stop unit terminal voltage table (reference)

| Terminal | Measurement conditions | Voltage (V) |
|----------|------------------------|-------------|
| 1AA | Up switch is pressed | 1.0 or less |
| | Down switch is pressed | Approx. 1.2 |
| | INFO button is pressed | Approx. 2.2 |
| | Except above | Approx. 3.3 |
| 1AB | Under any condition | 1.0 or less |

2016 Mazda MX-5
AUDIO SYSTEM (WITHOUT CENTER DISPLAY)

0920-1d

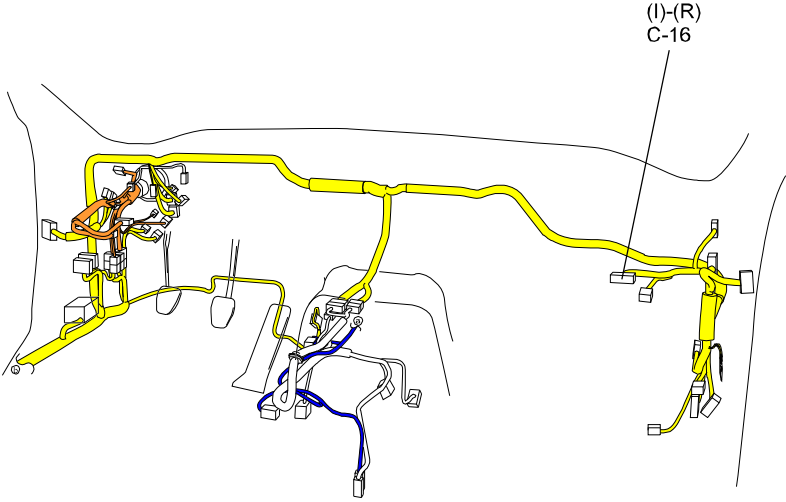
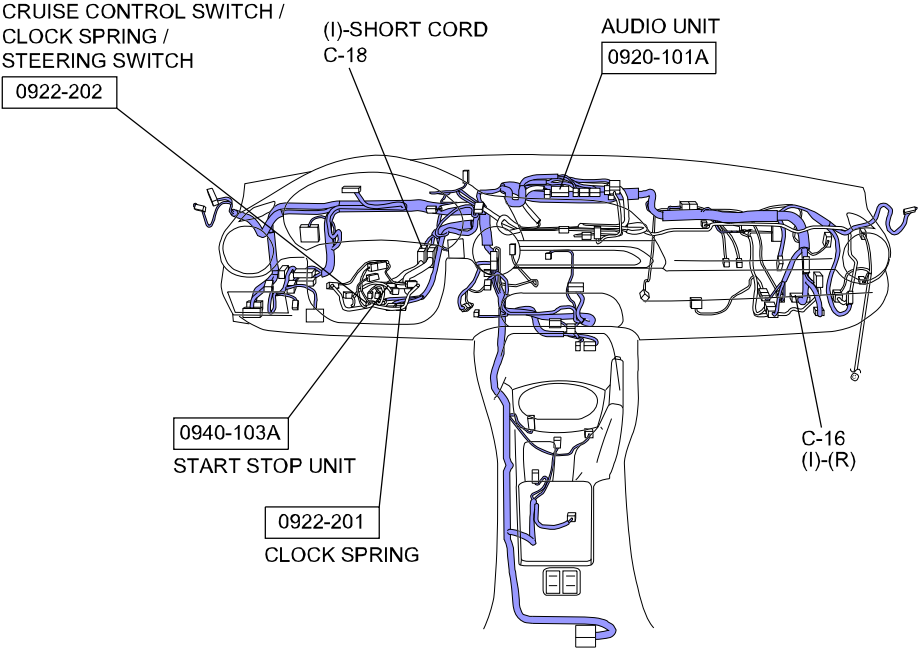

- FRONT HARNESS
- EMISSION HARNESS
- REAR HARNESS
- INSTRUMENT PANEL HARNESS

2016 Mazda MX-5
 AUDIO SYSTEM (WITHOUT CENTER DISPLAY)

0920-1e

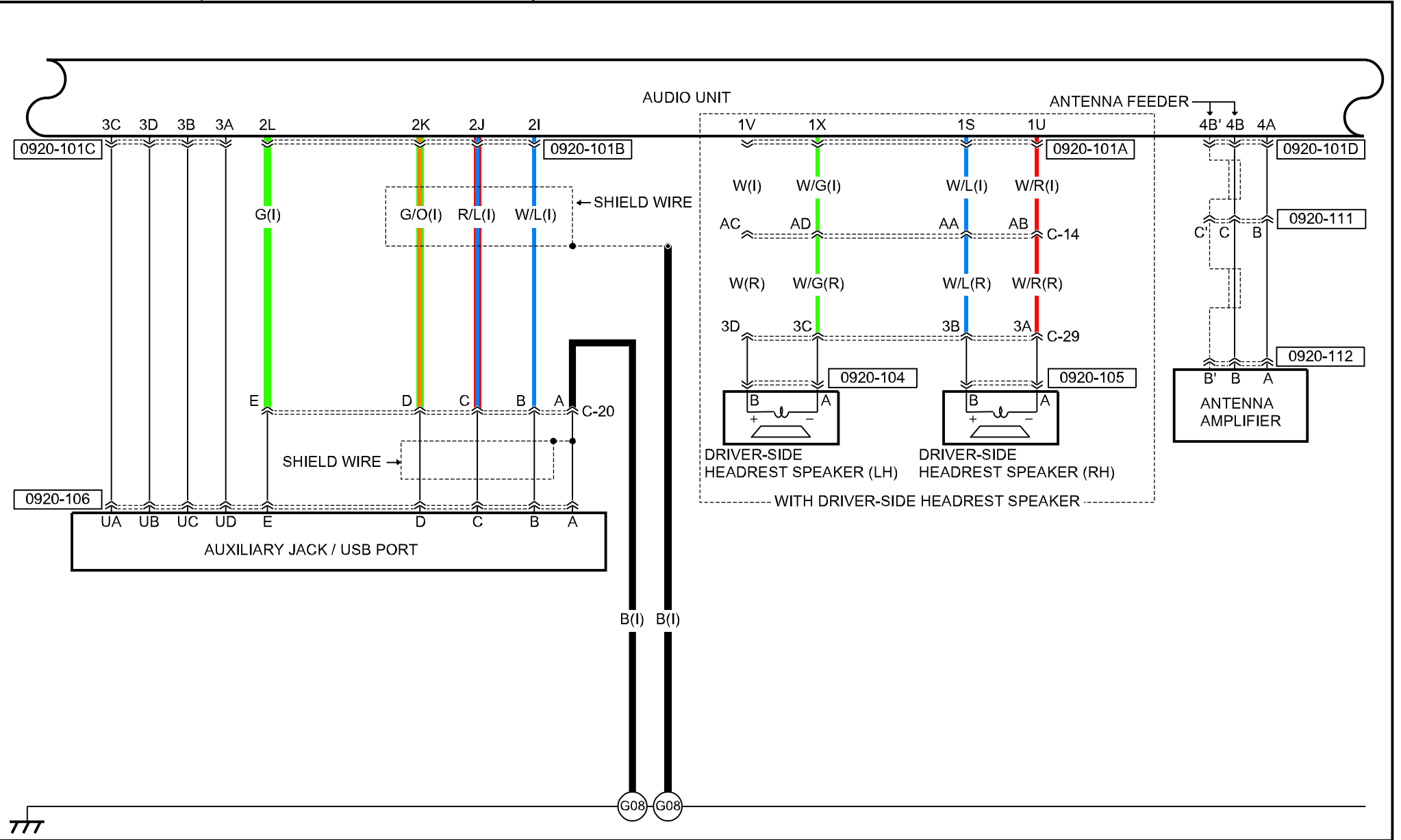

2016 Mazda MX-5
AUDIO SYSTEM (WITHOUT CENTER DISPLAY)

0920-1e

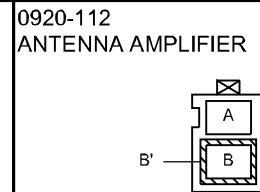
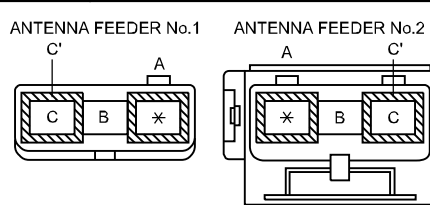
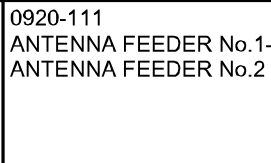
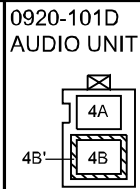
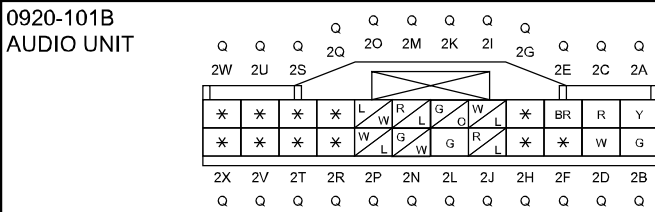
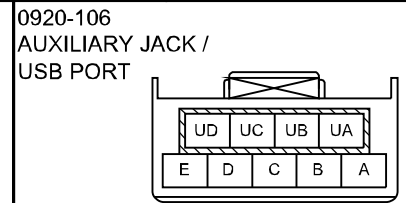
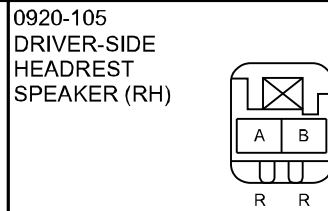
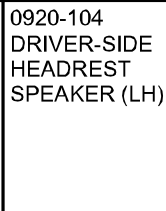
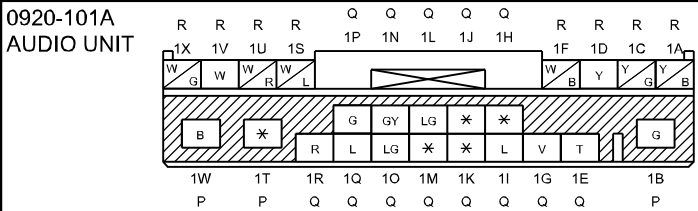

Headrest speaker

Headrest speaker resistance
Without Bose®: 3.4—4.6 ohms
With Bose®: approx. 4.0 ohms

2016 Mazda MX-5
AUDIO SYSTEM (WITHOUT CENTER DISPLAY)

0920-1e

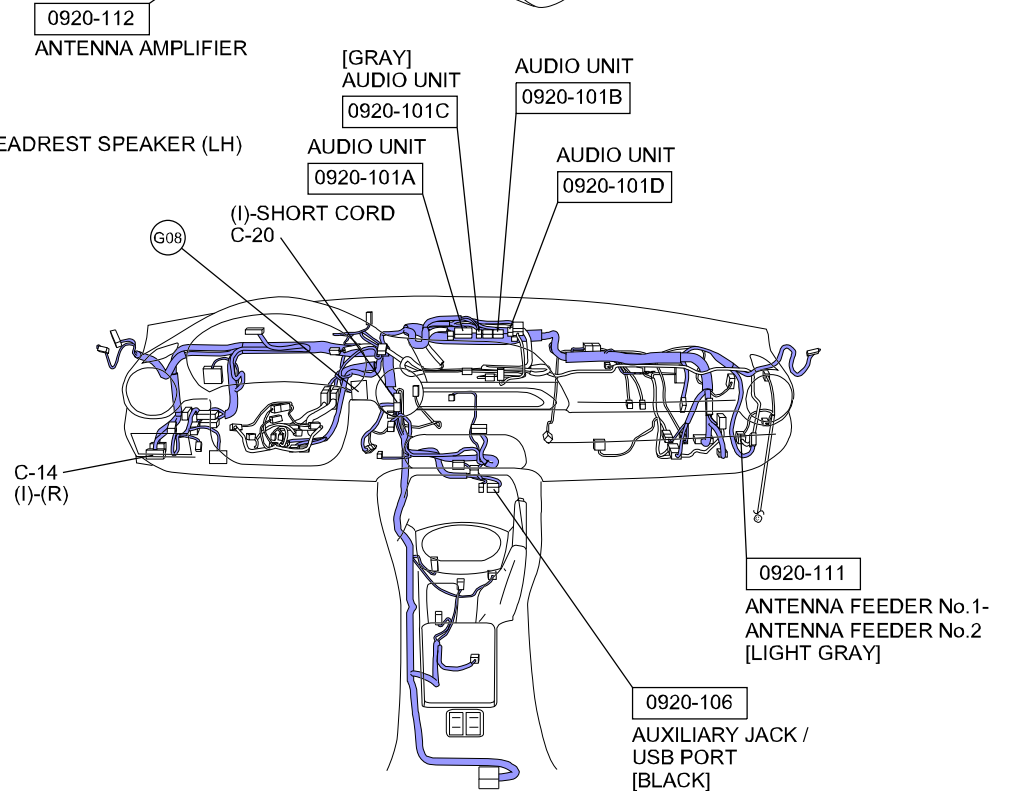
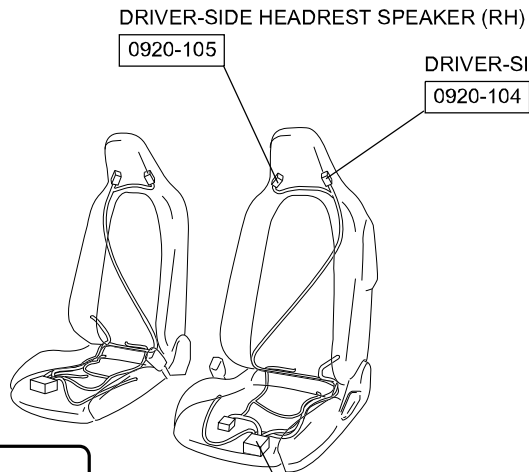
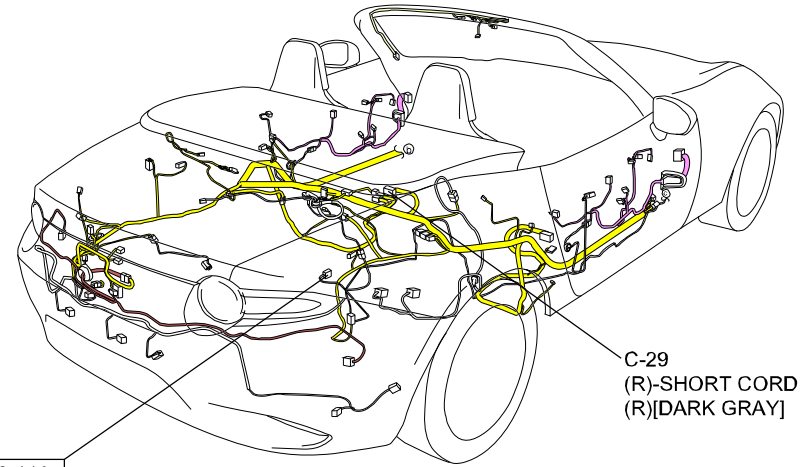
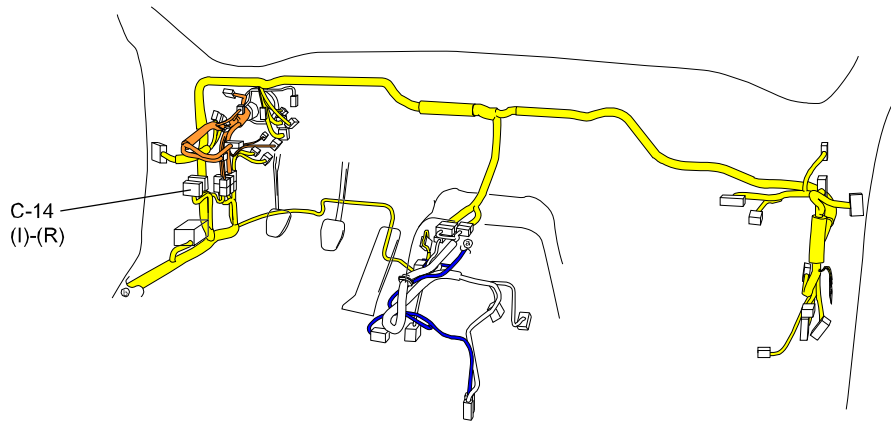

- : FRONT HARNESS
- : ENGINE HARNESS
- : ENGINE No.2 HARNESS
- : REAR HARNESS
- : REAR No.4 HARNESS
- : INSTRUMENT PANEL HARNESS
- : EMISSION HARNESS
- : DOOR HARNESS
- : INTERIOR LIGHT No.2 HARNESS

2016 Mazda MX-5
 AUDIO SYSTEM (WITHOUT CENTER DISPLAY)

0920-1f

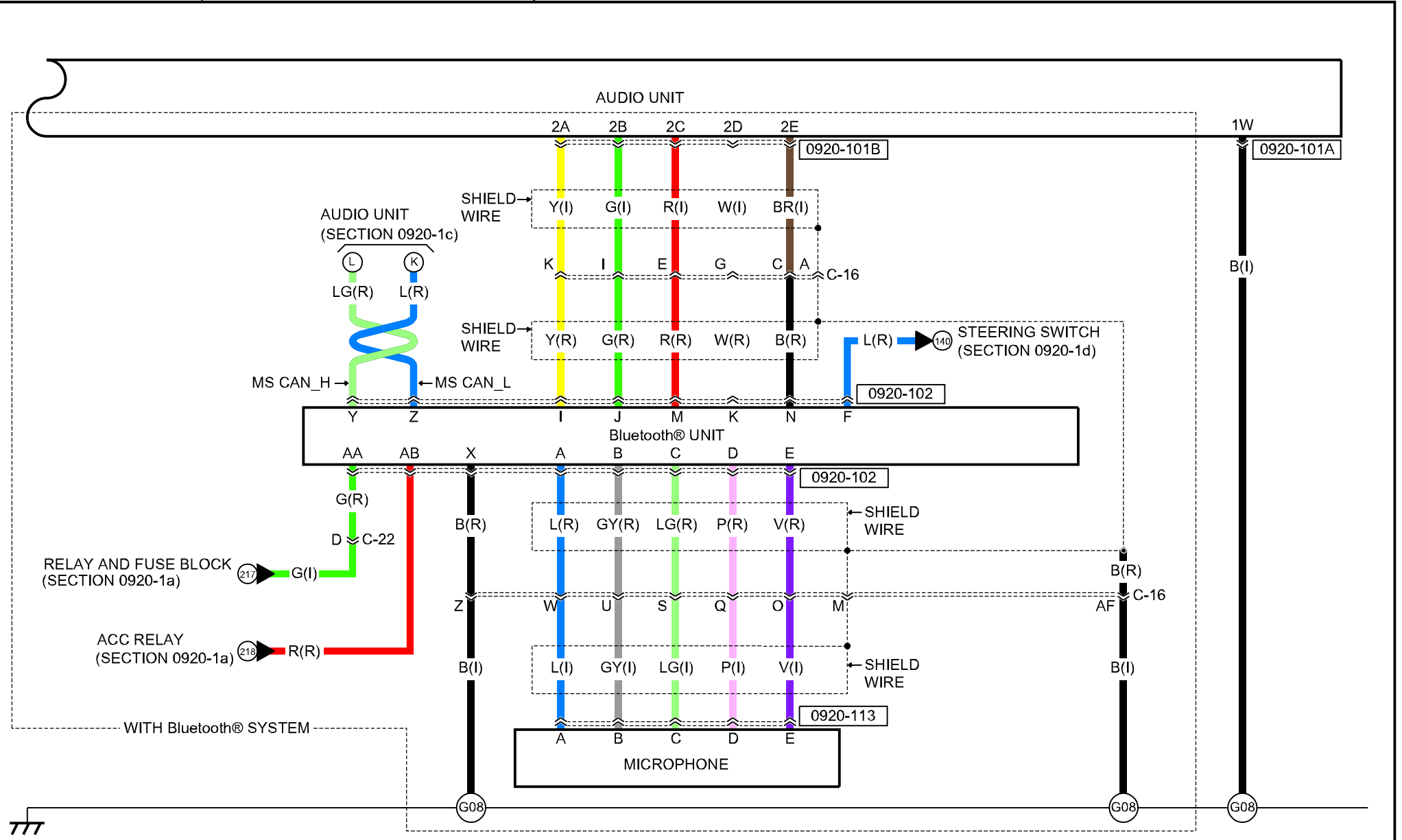

2016 Mazda MX-5 AUDIO SYSTEM (WITHOUT CENTER DISPLAY)

0920-1f

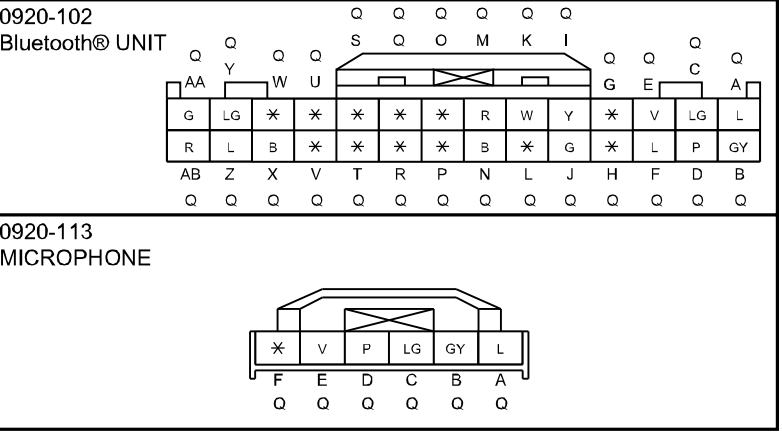
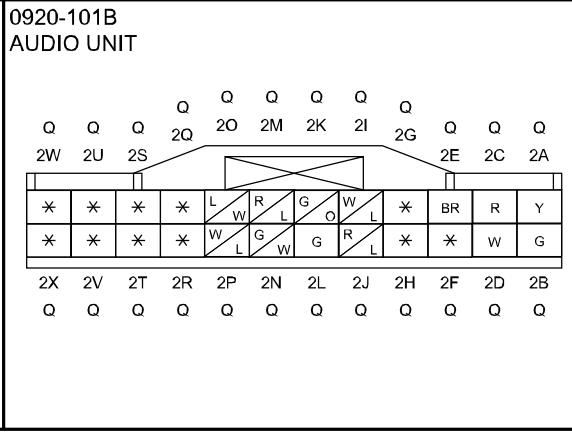
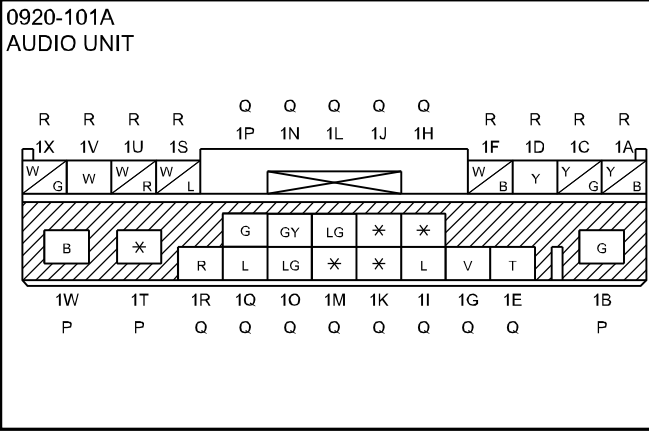

2016 Mazda MX-5
AUDIO SYSTEM (WITHOUT CENTER DISPLAY)

0920-1f

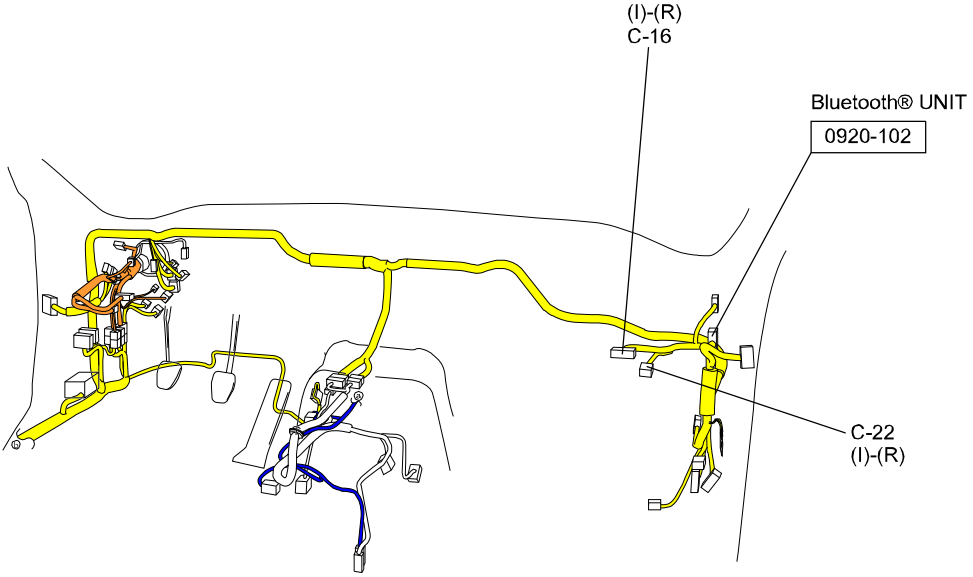
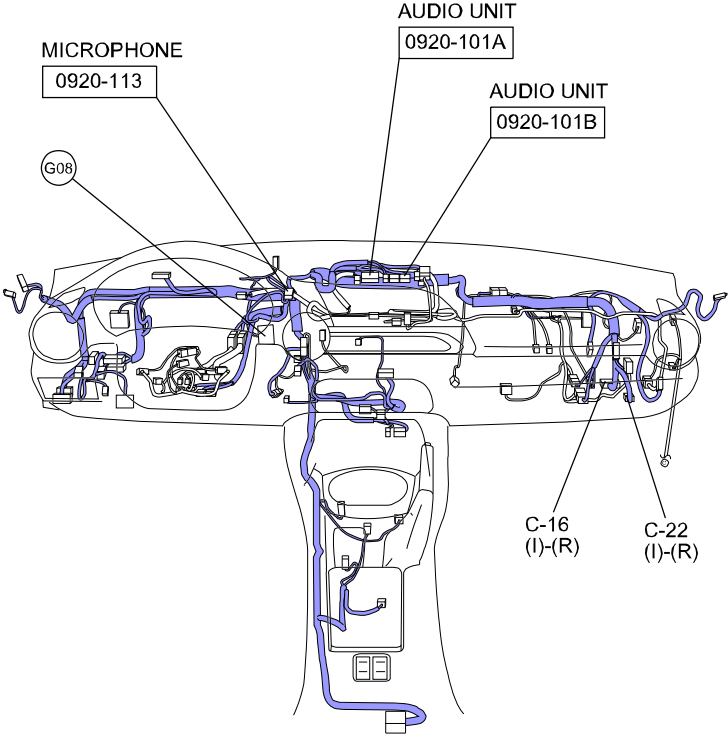

- : FRONT HARNESS
- : EMISSION HARNESS
- : REAR HARNESS
- : INSTRUMENT PANEL HARNESS